

THE WORLD CLASS OPERATOR

SPECIFICATIONS

**2** Jin Jiang Int.\*\*  
Hotels : 5.482  
Chambres : 555.544  
Evol. : +129,7%



Operated by Royal Tulip a member of Shanghai Jin Jiang International Hotel Group the second biggest operator in the world

<b>Bedroom</b>	Parquette Painted Painted Gypsum Board /Exposed Concrete Finish Doors/Windows Timber	<b>Master Bathroom</b>	Luxurious Marble Walls & Flooring Tempered Glass Shower Cubical Shower by Toto or equivalent Granite / Marble Vanity Top TOTO Premium Closet or equivalent
<b>Bathroom</b>	Luxurious Homogeneous Tile (Floor/Wall) Granite / Marble Vanity Top	<b>Balcony</b>	Floor Ceramic with natural texture Railing Wood
<b>Kitchen</b>	Pantry Hot water	Kitchen cabiner complete with sink and hob Individual Water heater	
<b>Other Value Added Features</b>	Electrical 3.300 VA AC Split Air Conditional Telephone 1 line	<b>Other Facilities</b>	Elevator 2 (two) units Spa Kids Play Room Meeting Room
<b>Security</b>	24/7 Hours Security with CCTV Camera Fire Fighting System with Sprinkles and Smoke Detector Fully Furnish - Bed - Curtain Sofa & Table - Television LED-32" - TV Cable & internet - Refrigerator - Wardrobe - Bedside table		



Corporate Founding Member of Green Building Council Indonesia

**Office :**  
Springhill Office Tower Lt. 16 -17  
Jl. Benyamin Suaeb, Ruas D7 Blok D6, Pademangan Timur  
Jakarta Utara 14410  
Telp. +62-21 658 66 509 | Fax: +62-21 658 66 928

**Marketing Site :**  
Jl. Jimbaran Hijau Kelod, Kel. Jimbaran  
Kab. Badung, Bali  
Telp. +62-361 8498 199

www.springhillgroup.id

ROYAL TULIP  
LUXURY HOTELS  
SPRINGHILL RESORT - JIMBARAN

A Green Masterpiece in Paradise

FACILITIES



EXCLUSIVE LOBBY



LOUNGE



SWIMMING POOL

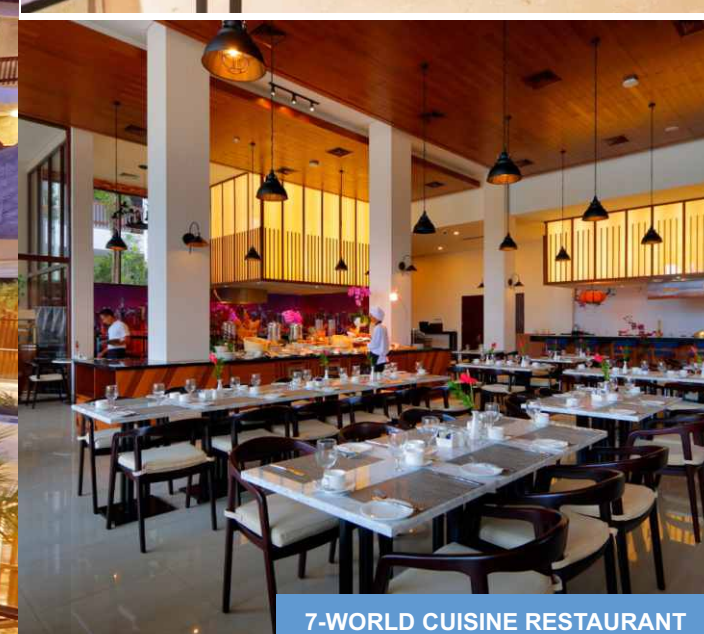

7-WORLD CUISINE RESTAURANT



YOGA SPOT

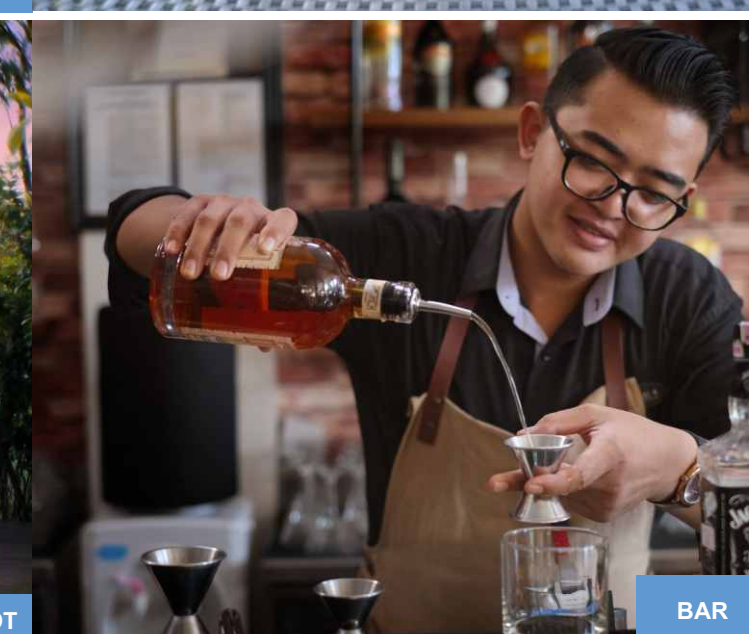

BAR



TIRTA AYU SPA



BUSINESS CENTER

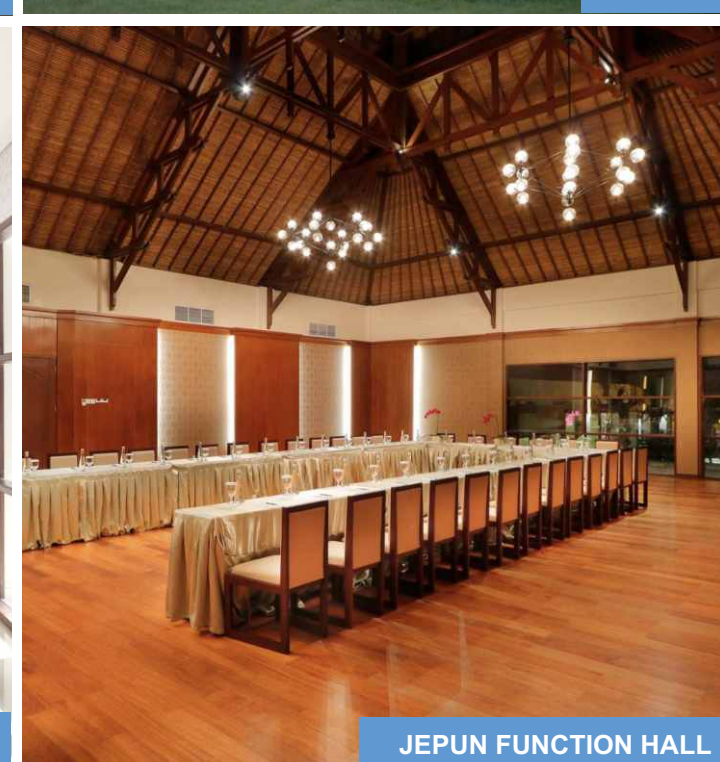

JEPUN FUNCTION HALL



CYCLING & JOGGING TRACK

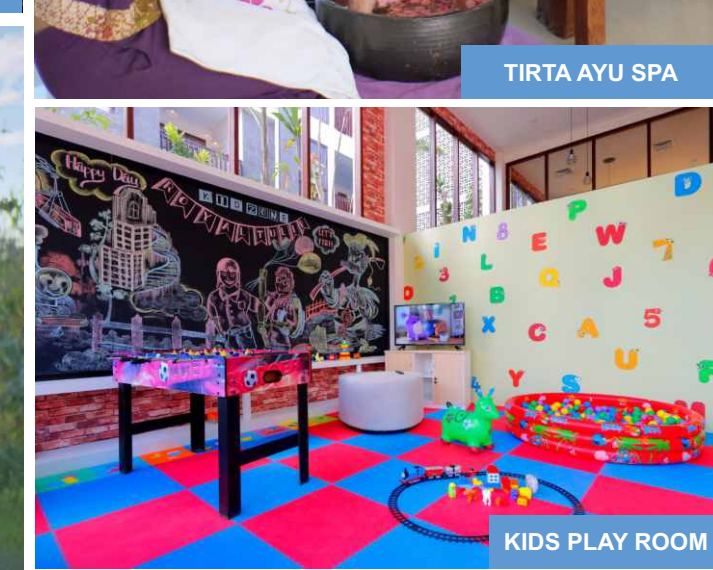

KIDS PLAY ROOM

WEDDING CHAPEL | COOKING CLASS

HOTEL AWARD



SOLAR PANEL

Have been awarded EDGE certificate in 2017 for excellence design, water and energy saving. Equipped with Green Energy from Solar Panel and water conservation system

21% Energy Savings | 20% Water Savings | 37% Less Embodied Energy In Materials

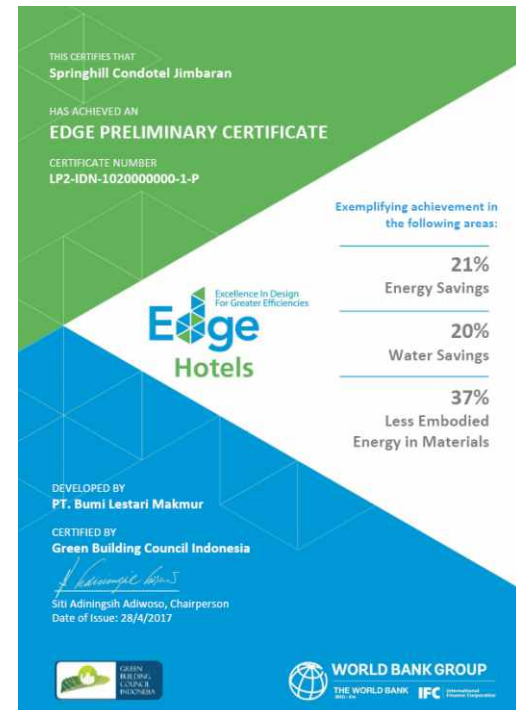

Have been awarded Certificate of Excellence from Trip Advisor in 2019



Indonesia Leading New Family Resortin in 2018/2019

Indonesia Leading New 5 Star Hotel in 2018/2019



# Block A

The simple yet comfortable Royal Tulip Springhill Resort - Jimbaran Blok A features an ensuite bathroom including bathtub, a master bedroom, a balcony, lift access as well as our standard amenities and facilities for the comfort of our guest.

- 1BR - Deluxe Suite / Deluxe Suite A
- 2BR - Family Suite

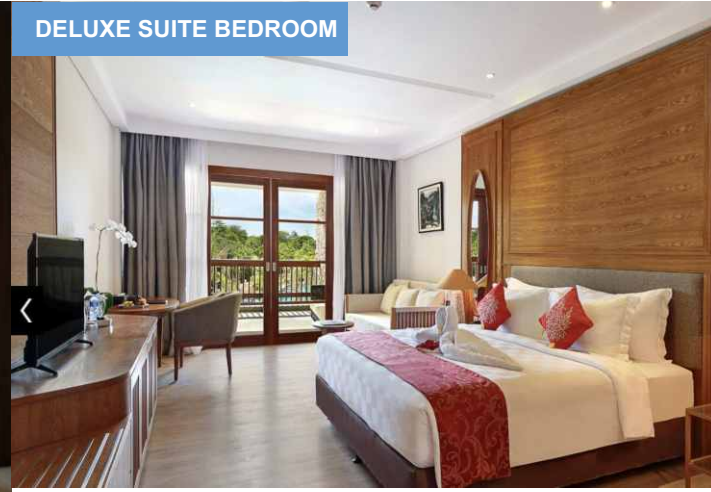

## Deluxe Suite

- 58 / 79 sq.m (Est. Nett / Semigross)
- Spacious rooms with parquet flooring
- Marble Bathroom with bathtub
- Spacious Balcony with pool view or forest in hills
- 1 Bedroom

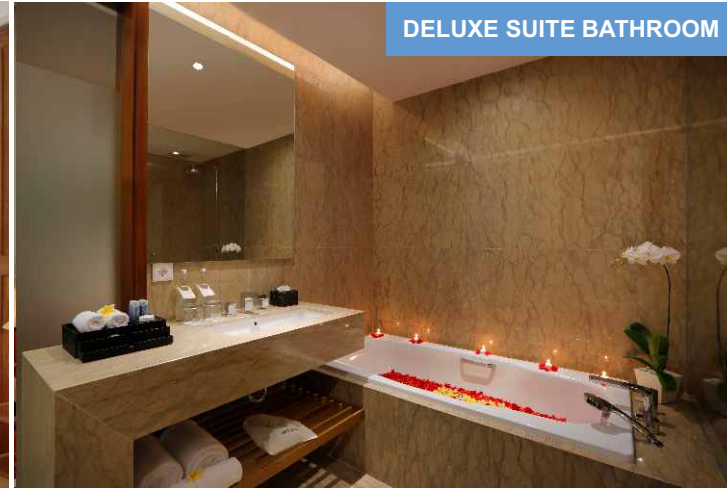

## Deluxe Suite Living Room

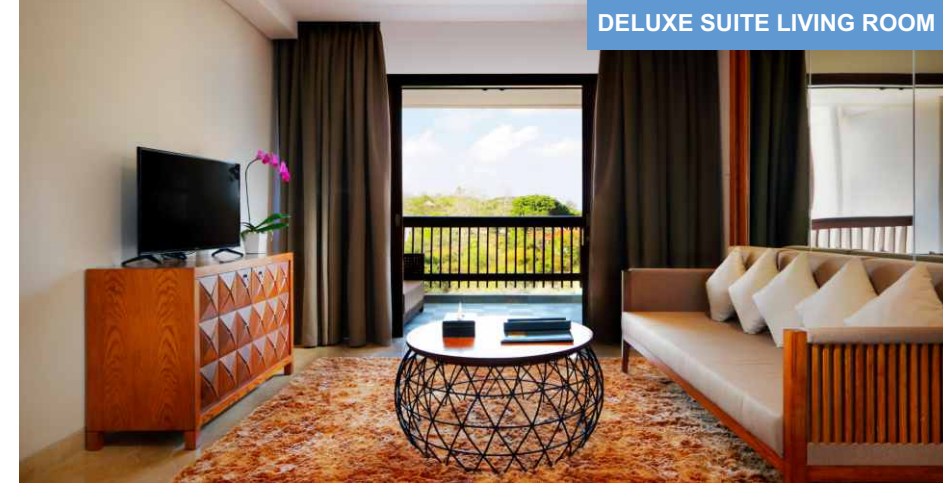

# Block B

The simple yet comfortable Royal Tulip Springhill Resort - Jimbaran Blok A features an ensuite bathroom including bathtub, a master bedroom, a balcony, lift access as well as our standard amenities and facilities for the comfort of our guest.

- 1BR - Deluxe Suite / Deluxe Suite A
- 2BR - Family Suite
- 1BR - Presidential Suite



## Family Suite

- 128/176 sq.m (Est. Nett / Semigross)
- Spacious Living rooms with Kitchen
- Marble & Parquet Flooring
- 2 Bath rooms
- Spacious Balcony with pool view or forest in hills
- 2 Bedroom



## Family Suites Living Room

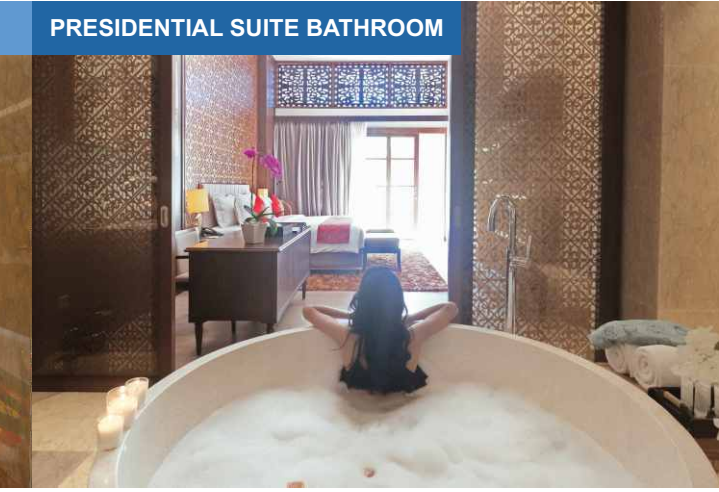

## Presidential Suite Dining Room



## Presidential Suite Living Room



THIRD AND FIFTH FLOOR PLAN

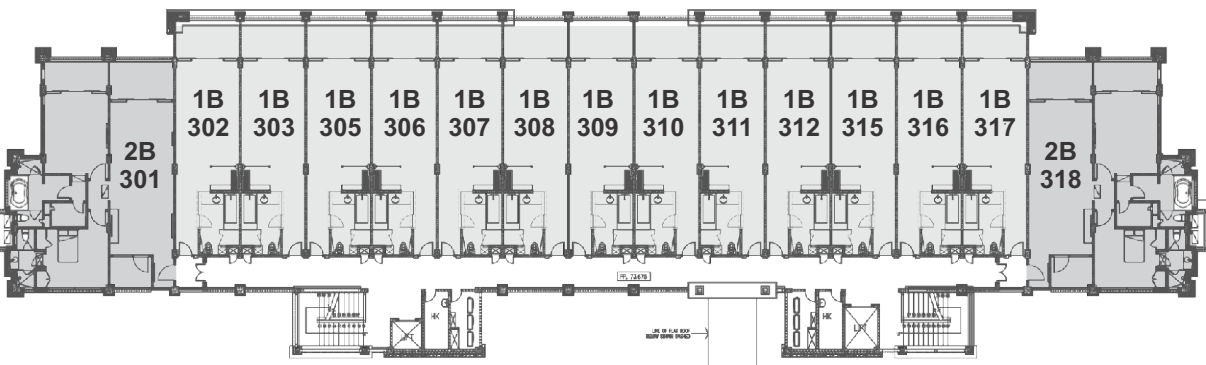

FIRST AND SECOND FLOOR PLAN

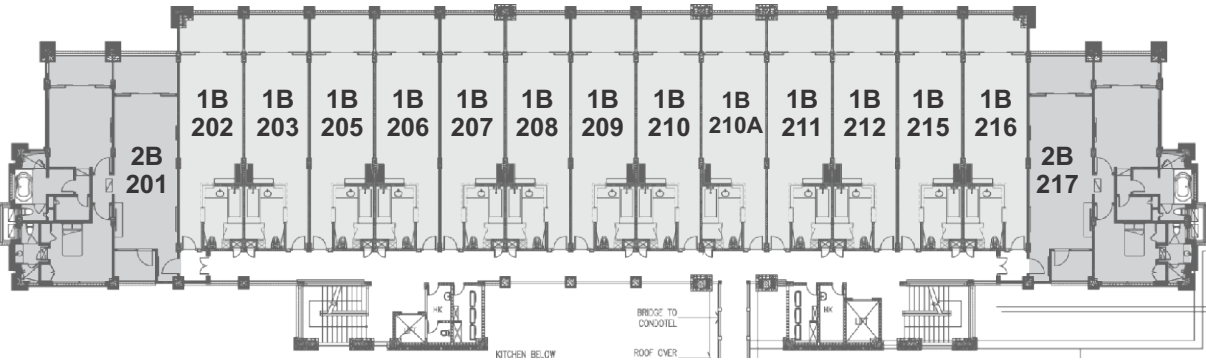

GROUND FLOOR PLAN

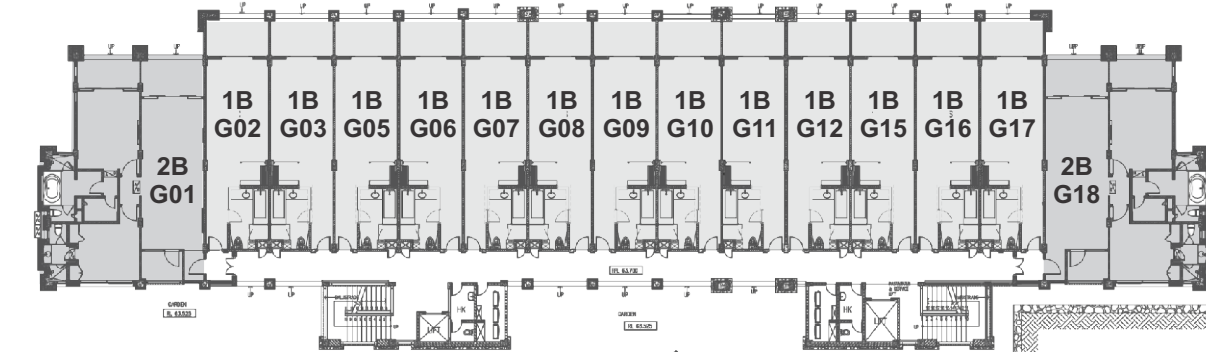

All information and specifications are current at time of print and are subject to change as may be required and cannot form part of an offer or contract. All plans are subject to any amendments approved by the relevant authority. Illustrations shall not be regarded as representation of fact. The developer retains full rights to alter or improve images without any prior notice.

SECOND, THIRD AND FIFTH FLOOR PLAN

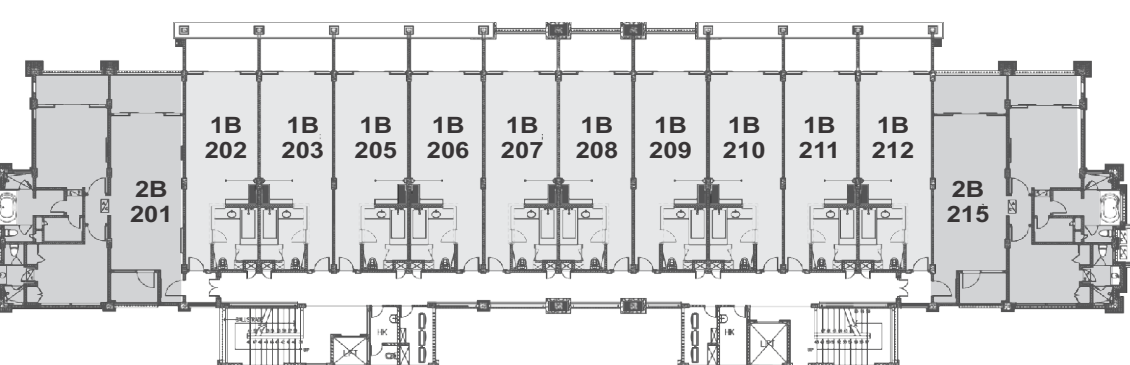

FIRST FLOOR PLAN

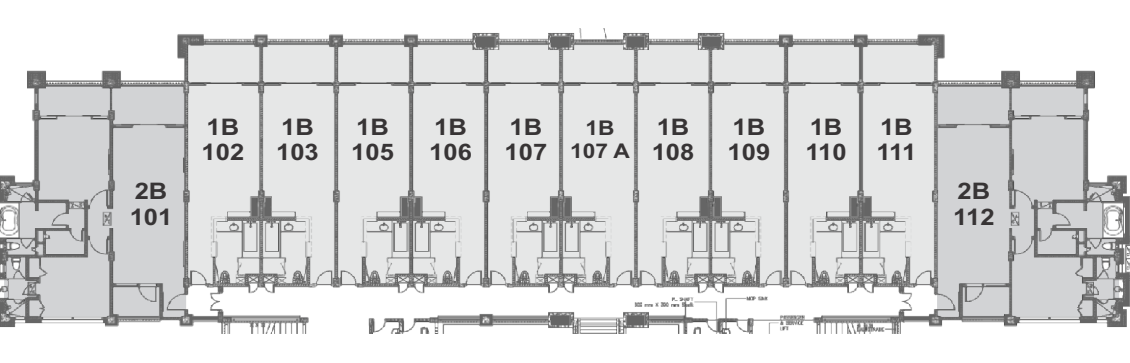

GROUND FLOOR PLAN

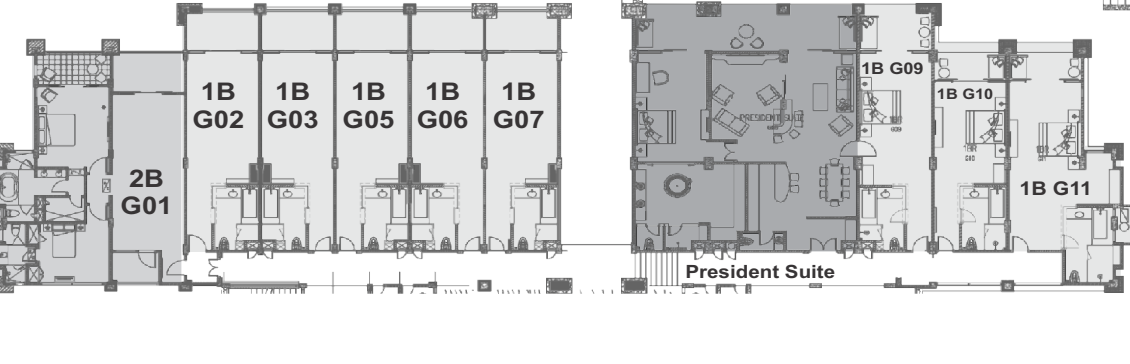

# Presidential Suite

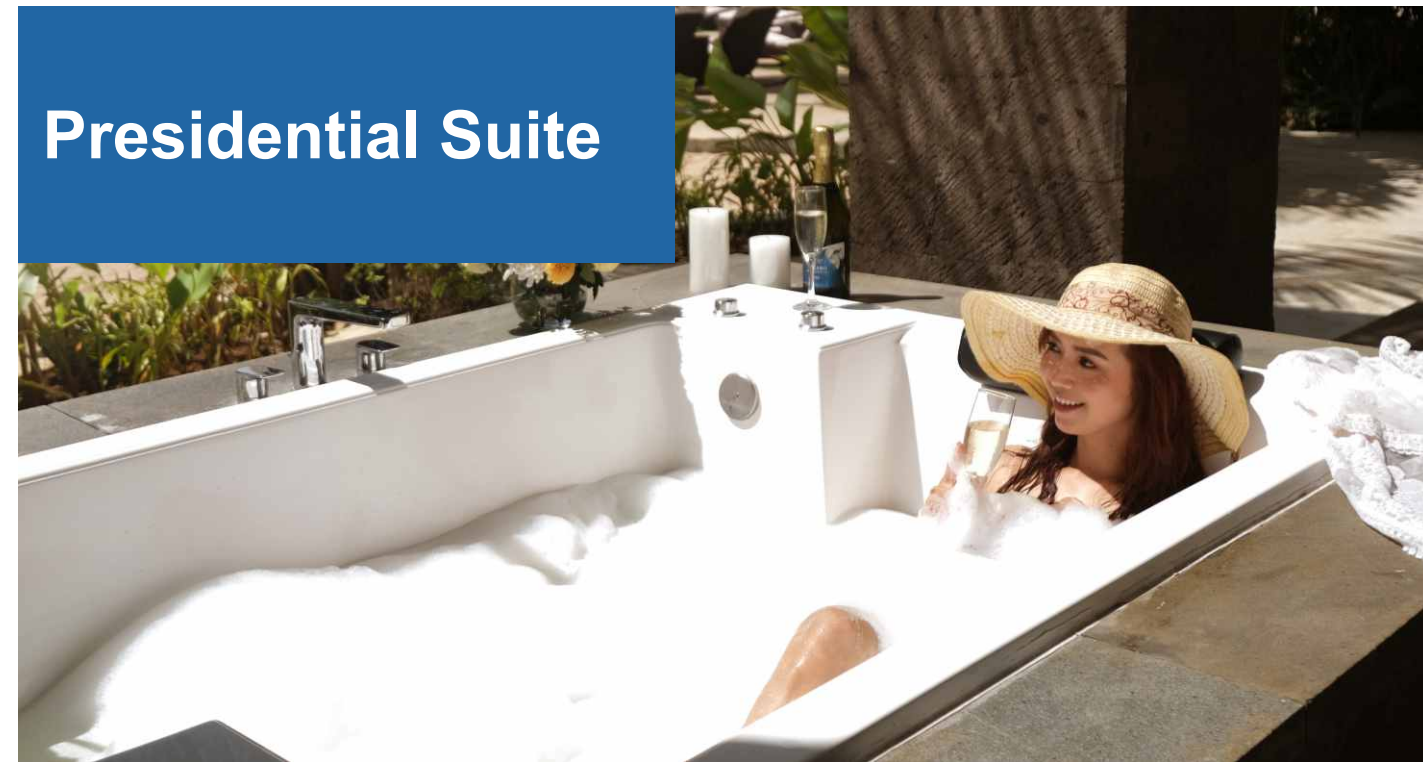

## Presidential Suite

- 172.39/213 sq.m (Est. Nett / Semigross)
- Home Theater Room, Dinning Room, Pantry, Living Room
- Spacious rooms with Marble and Parquet Flooring
- Marble Bathroom with bathtub
- Private Jacuzzi & Outdoor terrace with pool view or forest in hills
- 1 Bedroom

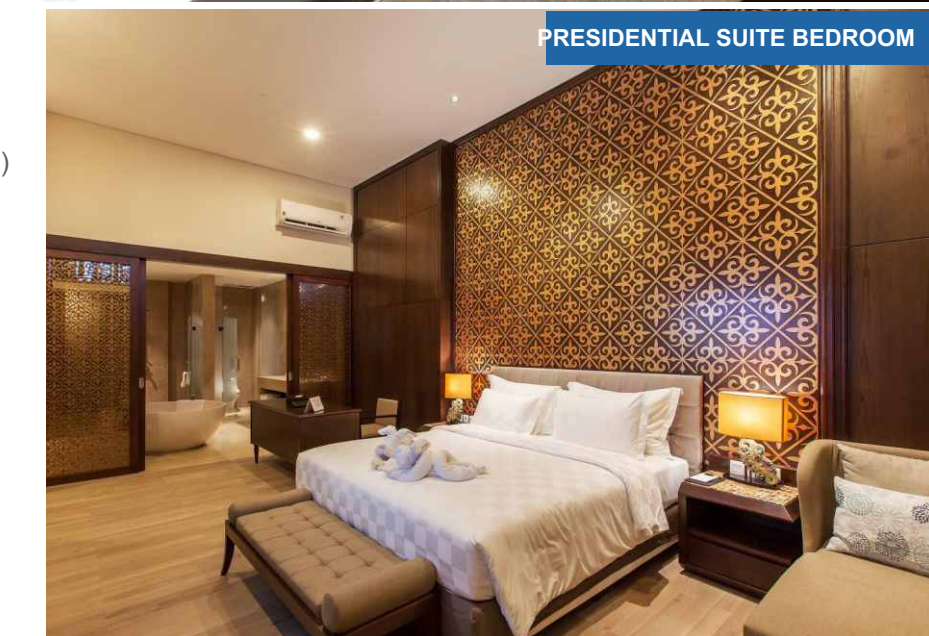

## integrated area

The spacious layout is design to keep you comfortable and relaxed. Its modern take on classical Balinese architecture makes it dream place for you to stay.

## MASTERPLAN

